

5/5

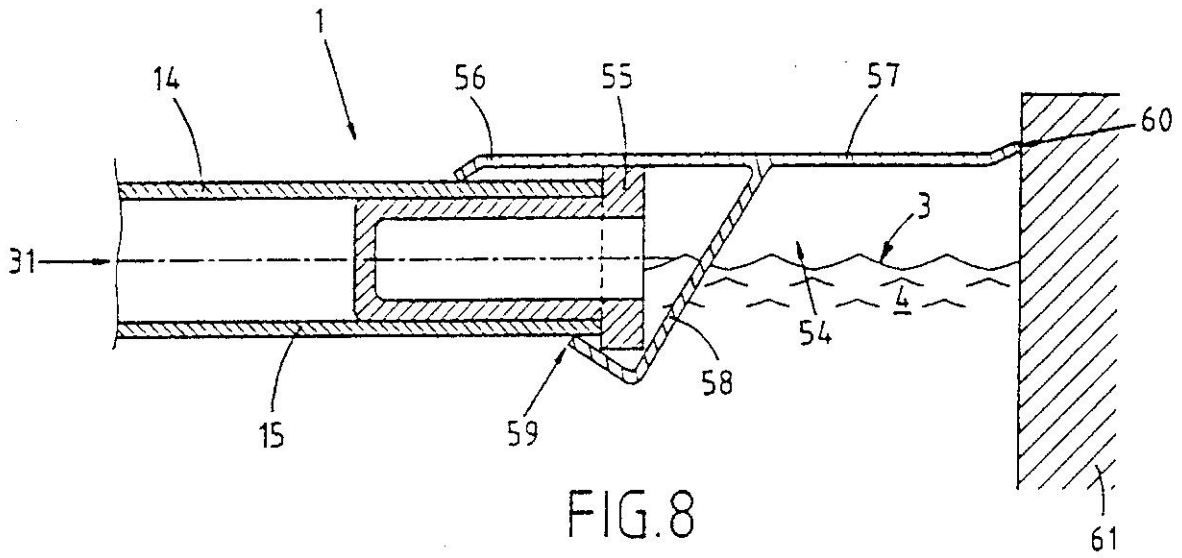

FIG. 8

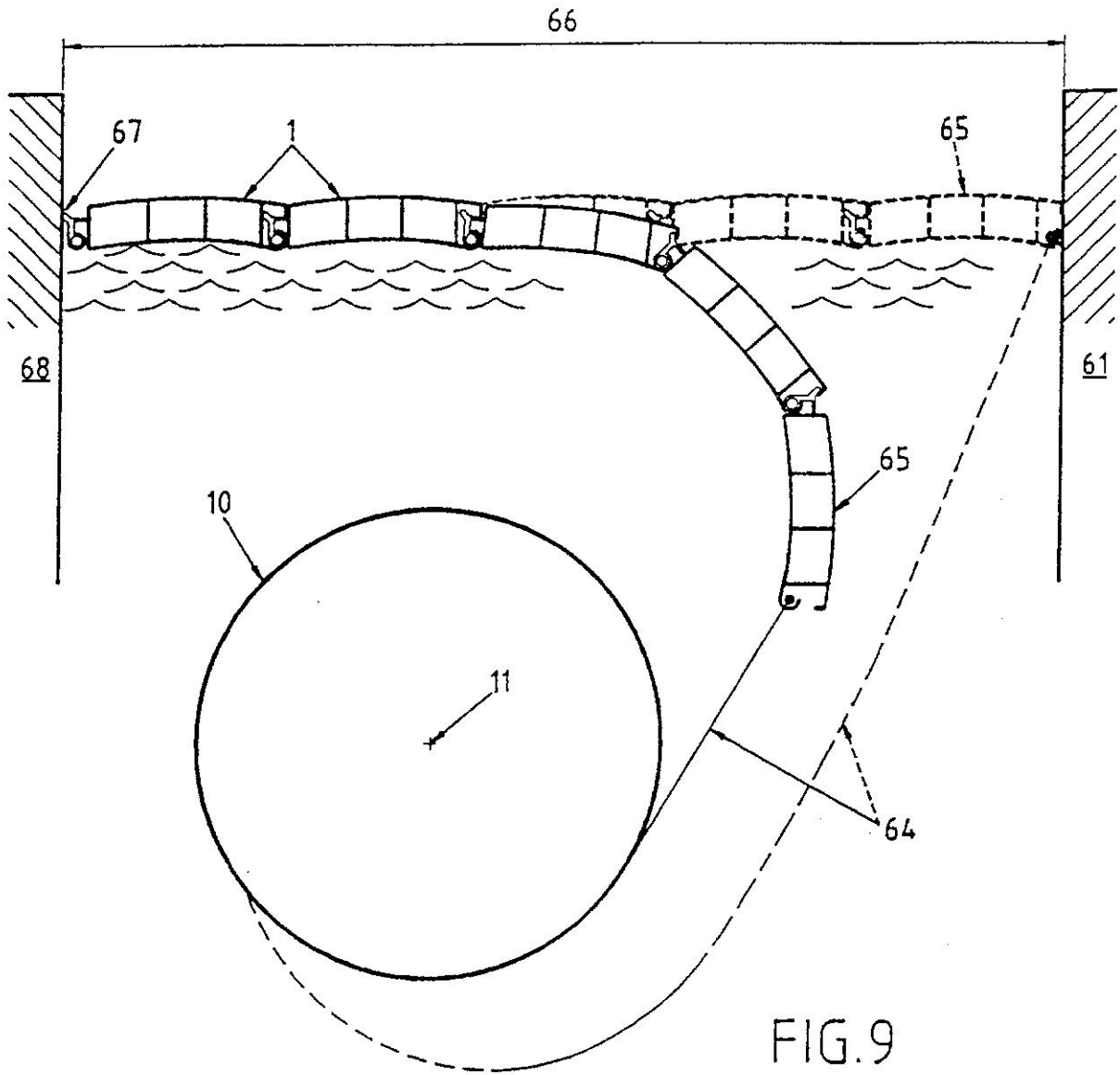

FIG. 9